

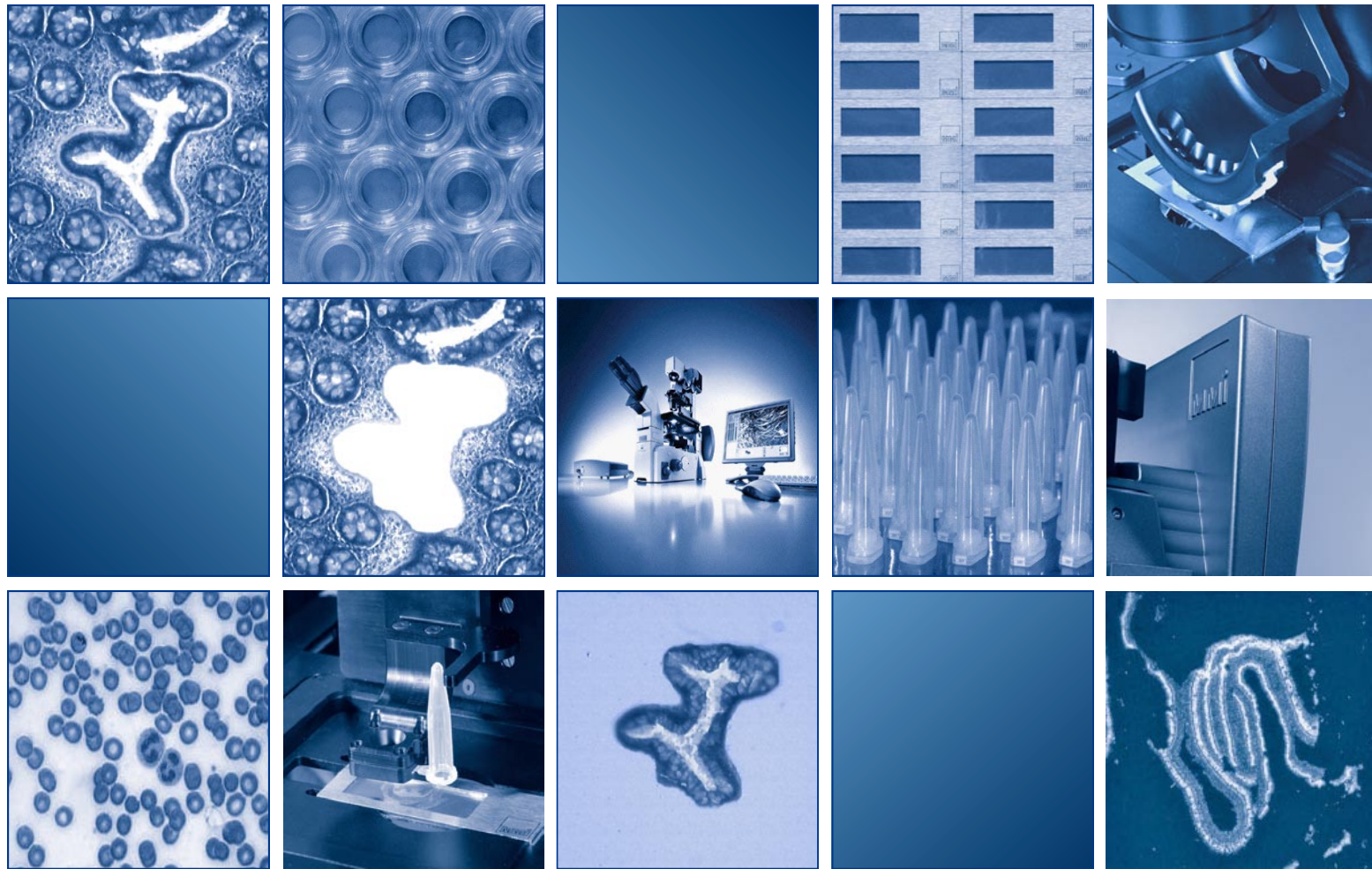

Molecular Machines & Industries

Laser Microdissection System mmi CellCut



NEW-GENERATION TECHNOLOGY

MMI is a leading company providing scientists with innovative and sophisticated instruments which introduced the use of solid state laser microdissection, making this core technology in many scientific fields more efficient and cost effective. The patented adhesive cap is reliable, clean and easy to use coupled with a touch screen technology for a more user-friendly, precise and ergonomic. As a business philosophy with the same tradition, the integration of the digital camera technology to laser microdissection is a step to the path of innovation.

The modular concept of the MMI instruments offers a high flexible instrument platform wherein optical tweezers, mechanical micromanipulation, fluorescence and other modules are adaptable to meet exactly your requirements. The biggest benefit for our customers is an instrument which is easy to use without limiting the capability of performing the most complex and stunning experiments.

Today, more than ever, it is MMI's goal to provide you with the highest degree of control possible. Our technology is aimed at keeping your samples away from environmental contamination and to easily inspect what comprises the source material of your experiment. This, of course, ensures the traceability and reproducibility of your work.

Our application support and service team is well-trained, experienced and understands that your goal is to achieve results as precise as possible with the MMI instruments.

We, the MMI team, are committed to our customers and we stand behind our products. That is why, we invite you to discover and innovate with us, leading the way.....

Sincerely yours,

MMI Team

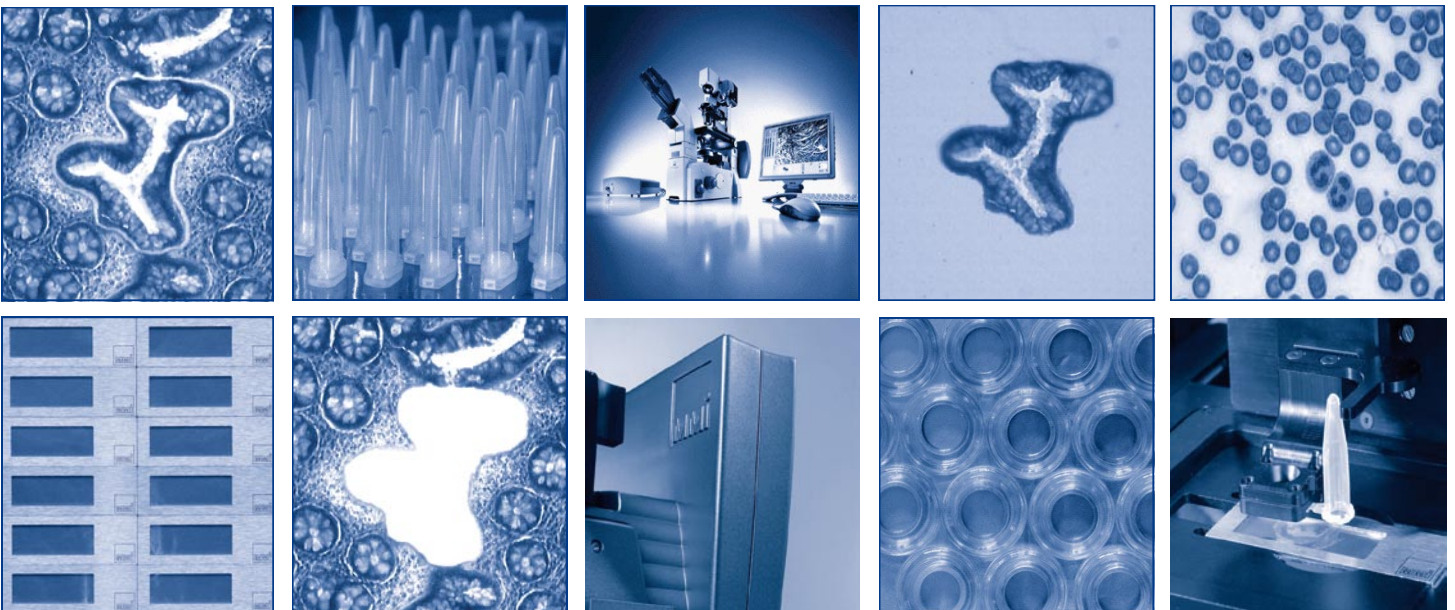

FIRST IN CUTTING-EDGE TECHNOLOGY

The mmi CellCut system is the ultimate laser microdissection tool of researchers who effortlessly wanted to isolate groups of cells, single cells and cell components for analysis across a wide range of applications.

mmi CellCut is ideal for scientists interested in the following areas of research: molecular/cell biology, genomics and proteomics, forensics, cancer and stem cell research. Clinically related applications such as molecular pathology, microbiology, and virology will also find the mmi CellCut of primary importance.

Principles of laser microdissection

A mmi CellCut combines several proven, leading-edge technologies in providing an extremely fast, precise and clean isolation of cells from a wide range of microscopic samples. This is achieved by dissecting the areas of interest with an ultra precise UV-laser while maintaining its morphology and ensuring the quality of the source material for subsequent downstream analysis without unnecessary induction of physical or chemical forces.

High-speed ultra fine laser cutting

The mmi CellCut system is fully controlled through the easy-to-use mmi CellTools software. This user-friendly program provides a live view of the microscopic sample on the monitor and allows the user to identify, mark and isolate the areas of interest easily.

For cell isolation, the maintenance-free, solid-state UV-laser is focused through the microscope's objective onto a microscopic sample to enable a cut width of as small as 0.3µm with the 100x objective. This, combined with a very short (pico-second) pulse duration and a high repetition rate, provides an ultra precise and fast target excision. The mmi CellTools software controls the focus and energy of the laser in microdissecting the area of interest while the laser remains aligned at the center. The highly precise motorized stage is used to accurately move the sample on the inverted research microscope.

Due to the very low (< 1 µjoule) pulse energy of the laser used in the mmi CellCut system, subsequent molecules like DNA, RNA and protein seems to be unaffected by the laser dissection process. This means that cells and cell components from frozen- and/or paraffin-embedded tissues, archived material, smears, cytopins, as well as living cells from cell cultures can be marked on the display of the microscope's image and microdissected without any negative impact on the quality of the source material for downstream applications.

Contamination-Free Isolation technology

B The unique mmi CapLift technology provides an automated transfer of uncontaminated targets from the entire microscope slide into micro centrifuge tubes. The captured samples adhere to the mmi IsolationCap of the extraction tube, which snaps close to keep the sample free from contamination and ready for downstream molecular biological analysis.

Key customer benefits:

- Ultra high precision laser cutting for the best laser microdissection results
- Ultra-short pulse, low average power laser for DNA/RNA/Protein quality recovery
- Maintenance free and certified long lifespan laser
- Retained orientation of microdissection samples to enable scientists to view the cells exactly as they appear on the tissue section
- Regions of interest can be inspected and re-worked after microdissection

A Principle of microdissection fast, precise and contamination-free

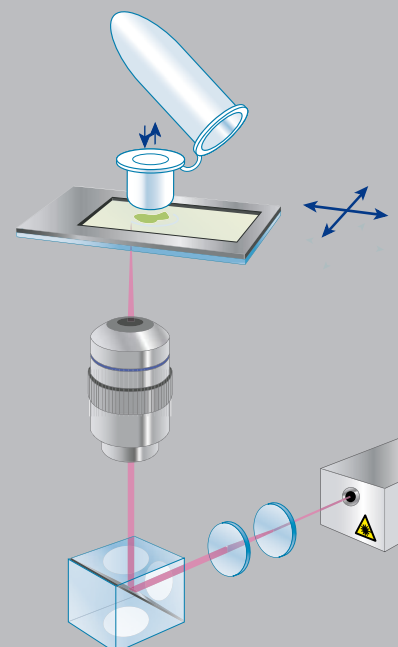

Computer-controlled movements
UV-Cut software-controlled laser focus and energy

B mmi CapLift technology



Application examples

A Tissue sections of colon

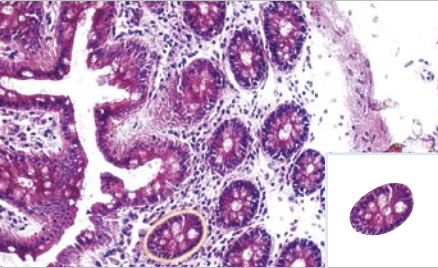

Multiple cells in pathological samples

A Differences in genomic (DNA/RNA) and proteomic expression of any tissue type can be analyzed easily. For example, transverse sections of intestinal glands from colon tissues can be identified and quickly isolated for study of specific genes and the corresponding hormone response.

B Blood smear with a typical plasmoblast

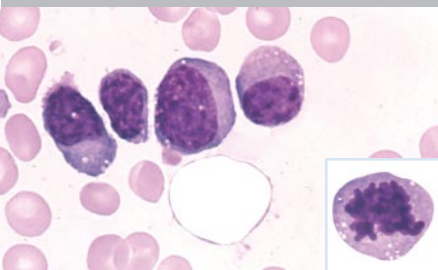

Single cells in hematology or cytology

B Single cells, such as a typical plasmoblast from a blood smear or other relevant cytological cells, can be identified, cut, and isolated with the mmi CellCut system. With the remaining sample securely attached to the mmi IsolationCap, it is easy to match the isolated cell and the remaining sample in documenting the precision and the efficiency of the extraction.

C Fluorescence stained chromosomes



Fluorescence-labeled cell components

C The precision of the mmi CellCut system also enables you to simply locate and cleanly microdissect structures smaller than single cells. For example, chromosomes with detectable fluorescence in situ hybridization (FISH) signals can be isolated for subsequent investigation.

D Single sperm isolated from a gynaecological smear



Forensic applications

D The mmi CellCut system in forensic medicine is used, among other applications to isolate a single sperm from a vaginal smear for genetic analysis, greatly increasing the possibility of a positive match and therefore possibly leading to a criminal conviction.

Other samples

E Living specimens like *C. elegans* can also be examined with the mmi CellCut system. Here, the living organism can be placed or fixed, between the membrane and a glass slide, in order to isolate and extract areas of interest as required by the individual experiment.

E Live *C. elegans* fixed onto a membrane and isolated.



Live cells

Most stem cell lines are presently grown at high densities on mouse fibroblast "feeder layers". Therefore, isolating specific pluripotent cells from the surrounding fibroblasts and differentiating cells needs to be fast and precise. With mmi CellCut, there is a perfect balance between speed and precision, allowing the target stem cells to be isolated and re-cultured without any side effects, such as karyotype changes.

Basic laser micromanipulation

The mmi CellCut system can also be used as a laser micromanipulation system. Single, short laser pulses produce small self-sealing holes in the plasma membrane of a living sample, which improves protoplast fusion or increases the transfection rates of exogenous substances.

Proteomic Applications

In proteomic research, several thousand cells are needed to run Western-blot or two dimensional gels. Using the mmi CellCut enables scientists to quickly microdissect cells of interest without any potential damage, as compared to alternative methods like polymer thermo-excitation or cell projection.

QUICK AND CLEAN TARGET ISOLATION

Unique system for sample preparation and sample protection

F G For the sample preparation of any source such as frozen or paraffin embedded, smears or cytopins and chromosomes spreads, the mmi CellCut system uses the mmi MembraneSlides. This special frame slide is covered with a thin membrane that is completely inert and has negligible auto fluorescence. The different types of samples are prepared on this membrane and are covered with a normal glass slide for protection against contamination.

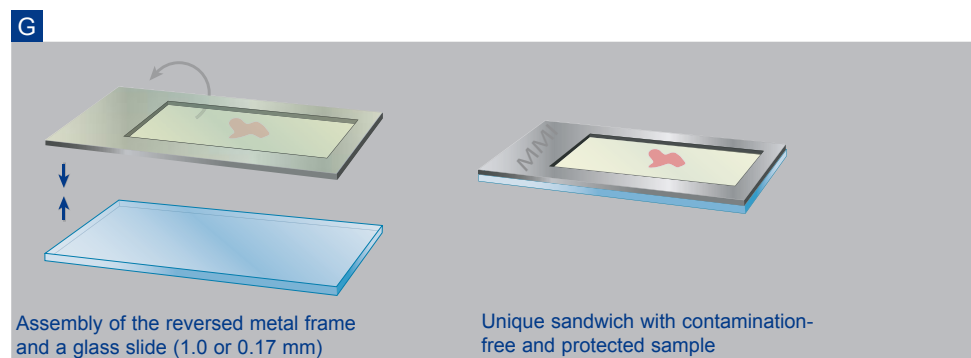

Selection and cutting

H Using the mmi CellCut software, microdissecting the regions of interests are selected on the display either by using the mouse freehand or predefining geometrical shapes, such as circles and squares. Any number of areas across the entire slide can be identified as targets and the sizes of the geometrical shapes can be changed as well as copied and pasted for consistency.

Fast, precise and clean excision

The thin (0.3 μm at 100x) cutting path enables a precise and comfortable extraction of the selected areas at an outstanding speed without affecting its morphology or otherwise, negatively affecting the areas of interests. As a result, there is no loss in quality of the material used in subsequent steps. Even the viability of living cells is not affected and therefore, the cells, once selected, can be re-cultured. Depending on the sample type, several thousands of cells can be laser dissected under a minute.

Ready for “downstream” analysis

I The mmi IsolationCaps used in the mmi CapLift technology allows the collection of target areas across the entire microscope slide. After microdissection, the mmi IsolationCaps are snapped into the micro centrifuge tubes to undergo extraction of the bio molecules. After using the recommended extraction reagents and at the desired incubation time, the extracted targets are now ready for further genomic and proteomic processing.

Key customer benefits

- **Unique mmi sample preparation and protection system allowing contamination-free working conditions (RNase/DNase free and safe from environmental contamination)**
- **Simple and comfortable working processes for more efficient results**
- **The only system which allows reworking already isolated areas without the need for a larger area ablation**
- **Best results are even achieved from limited source of material; optimizing technology to ensure DNA and RNA quality**
- **Keeps you in control of your research work without compromising speed and efficiency.**

F Sample preparation on frame slide with PET membrane

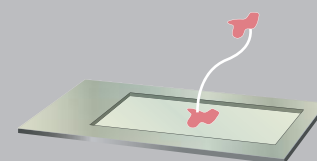

Cryo or paraffin-preserved tissue

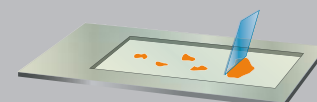

Single cells, smears or cytopins

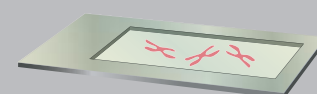

Chromosomes

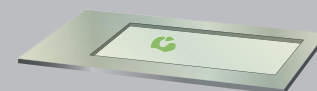

Others, e.g. sperms, C. elegans

H Easy cell selection

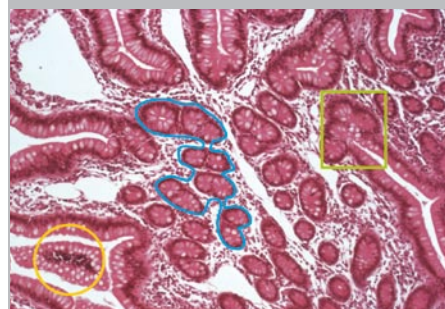

I Selected target Incubation and centrifugation

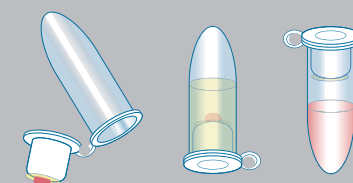

A Cell culture in phase contrast observation



B Excision of live cells on a microscope

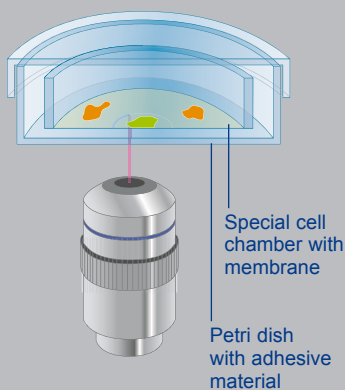

C Positive selection under clean bench conditions

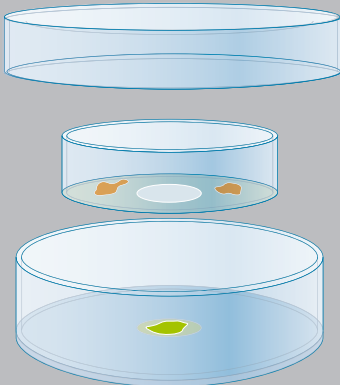

D IBIDI 18 well μ -Slide 2.0 PEN membrane, sterile

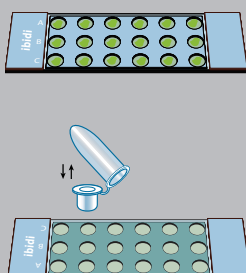

Microdissection of live cells

A The standard MMI live cell microdissection is done by using a mmiCellChamber which consist of two parts, namely: an inner stainless steel ring with a membrane at the bottom where live cells can be cultured and a glass Petri dish with an adhesive gel at the bottom. The cells grow within the stainless steel ring under sterile standard conditions, protected in a standard Petri dish in an incubator.

B Prior to microdissection, the stainless steel ring is placed in a Petri dish with an adhesive gel bottom. To isolate live cells, the CellChamber is placed on the microscope stage where areas of interests can be positively or negatively selected, microdissected or ablated by the laser without any need of opening the dish or draining the growth medium. The laser quickly and precisely cuts only the membrane for easy separation of the adherent targeted live cells.

C Back under fully aseptic conditions, the stainless steel ring is then removed from the Petri dish, leaving behind the positively selected and isolated cells which adhered to the bottom and is ready for further cell cultivation. The original stainless steel ring can be discarded or if required, can be place in a new Petri dish any number of times to isolate different cells from same culture.

With this process, the cell cultures can remain in the growth medium without exposure of laser energy at any point within the process of isolation. This way, the risk of loosing the experiment is minimized either by exposure to stress or by environmental conditions.

D There is a new high throughput live cell handling with the mmi IsolationCap technology together with the 18-well IBIDI μ -Slides.

Through this new method of extracting cell cultures, MMI accomplished an improved sectional view and increased cutting efficiency. At the same time, it also allows the use of the mmi IsolationCap technology with its known and proven advantages guarantying a contamination-free and careful handling of the cells.

Key customer benefits:

- **Cells are not exposed to environmental conditions, minimizing risk of contamination.**
- **The laser beam is not directed to the live cells during the selection or extraction process**
- **No risk of exposure to any thermal or laser pulse energies that would alter genomic profiles of the cells.**
- **Comfortable and easy to use method, no special training is required**
- **Source cells and segregated cells can be used for downstream applications**
- **Use of growth media is controlled, no unnecessary waste of resources**

INTUITIVE SOFTWARE

The mmi CellTools software is used to control the mmi CellCut system. Its graphical user interface allows the precise and intuitive identification and selection of the areas of interests to be excised for the isolation processes. In addition, it provides full control of the system, laser cutting parameters, type of objective used and the specific camera settings related to each different application.

With a fully motorized microscope as its basis, even the automated microscope functions such as objective changes, condenser settings and fluorescence turret changes can be initiated via the mmi CellTools software. With this user-friendly software combined with the optional PenScreen operation, the mmi CellCut system simply makes the most complex experiments possible and will take you to new levels of efficiency.

Overview, easy navigation and positive target identification

E F Using a low-magnification objective, an overview scan of the entire microscope slide is taken, allowing easy navigation of the whole slide. As well as to find areas of interests or positions, the mmi IsolationCap is then placed in the inspection mode by clicking the mouse button. In addition, when using the mmi MultiSlide option, the overview and easy navigation are extended on all slides.

The user-defined inspection mode position is easily set by pressing a button on the navigator screen and can be reset at any time.

Laser control

G The common laser parameters such as speed, focus and power can be set to match the individual needs of each application, sample or objective. Once set, the parameters are stored for easy retrieval and can be edited at any time.

Automated full-slide selection and extraction

While the areas of interests are all over the entire microscope slide, you can select and extract from the whole slide area; whereas the software will automatically move the mmi CapLift over the slide to the right position and pick up the microdissected areas. This saves a significant amount of time in the isolating process. Together with the mmi MultiSlide and mmi MultiCap options, the system automatically extracts targets from up to three slides and collects in up to eight different mmi IsolationCaps.

Auto documentation

H All the relevant data within a session can be stored via the auto documentation mode. This includes the number and size of the cut-out areas, as well as instrument settings and laser parameters. The isolated targets are documented by the mmi CellCut system during the cutting and isolation process and pictures of the remaining samples are also automatically taken and saved.

This enhances traceability of your research work and a given proof of a clear, clean and quick isolation processes. Images can be saved as TIFF, JPEG, BMP or TGA files.

Key customer benefits:

- **Easy to use and intuitive software interface enabling intensive focus on your research work**
- **All control parameters are clearly structured on display**
- **Versatile plug-and-play options for individual needs**
- **Simple and efficient auto documentation of your work**
- **Same user-friendly interface for others MMI products for simple expansions and upgrades**

E Display for easy navigation

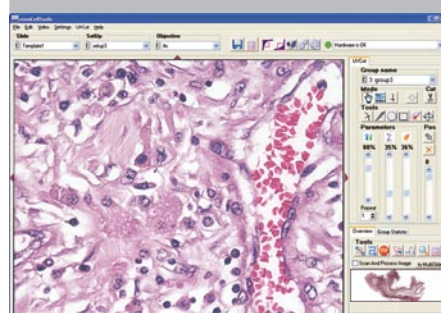

F Toolbar and navigation overview



G Laser parameter control Clear and intuitive setting

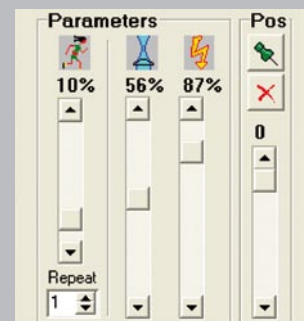

H Automatic documentation Options

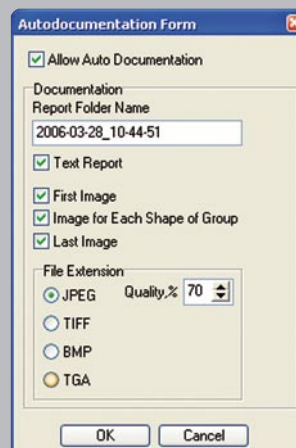

SYSTEM INTEGRATION

A Dual-level laser coupling Scheme of different light parts

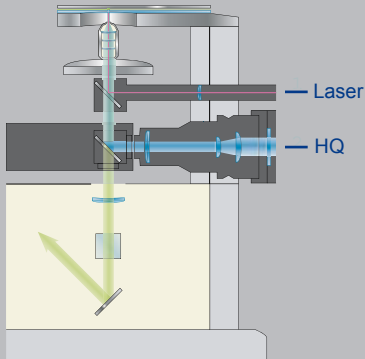

B Fluorescence up to six fluorescence filter cubes



C mmi CellCamera high resolution digital camera



Inverted microscopes are designed to provide researchers with a high performance and versatility required for a wide range of research activities. The mmi CellCut is fully integrated with the inverted microscope, maintaining all the properties and options of these research instruments without experiencing any limitations while using our microdissection system. MMI has a fully integrated automatic microscope giving you all the advantages of these technological advances for direct control, easily and intuitively with our mmi CellTools software.

Optical bench flexibility

A With multiple ports and dual-level laser integration, the microscope offers the “optical bench flexibility” enabling the use of different modules and imaging technologies to be used without any limitation or extensive equipment changes. The system-integrated digital camera is connected to the standard left side port; whereas, other cameras may be added at different ports according to your individual needs.

Standard fluorescence without limits

A B The dual-level coupling of the solid state UV-cutting laser also ensures that the microscope may be used fully for the whole range of fluorescence applications. For example, six fluorescence cubes can be used and therefore, additional or specialized dichotic optics or external filter wheels are not necessary.

In conjunction to the mmi CellTools software’s freeze mode for fluorescence images, the mmi CellCut system provides a perfect combination for fluorescence applications and laser microdissection adaptable to your needs.

The L-shaped fluorescence condenser is attached for easy handling of the 100W mercury lamp house. Furthermore, all available options including the fibre optic cold fluorescence illumination or other external lamp houses can also be used.

The mmi CellCameras

C MMI is the first to offer ultra high sensitive cameras for laser microdissection applications in addition to the traditional CCD camera. The new digital mmi CellCamera with its compact dimensions and outstanding performance allows your system to fit the most complex demands.

These ultra high sensitive digital cameras are especially developed for laser microdissection applications and are available in colour/monochrome version specifically configured for fluorescence applications. Both cameras can be mounted at the same time to the mmi CellCut system. Its outstanding image quality due to the ultra-light sensitivity and advanced passive cooling concept having the advantages of digital photography provides exceptional performance.

Key customer benefits:

- **No laser interference on microscope functions due to dual level coupling**
- **All standard microscope options remain intact while using the mmi CellCut**
- **Freeze mode for fluorescence images avoids bleaching of cells**
- **High quality imaging and contrast with mmi CellCamera**
- **Cold fluorescence light source has 10x longer lifespan as regular lamp with alignment free operation and no heating of the samples**

MODULAR UPGRADES AND OPTIONS

For more advanced functions and different requirements, the mmi CellCut system can be upgraded and complemented with a number of useful additions.

D PenScreen – A sensitive PenScreen can easily be used to operate the mmi CellCut system in selecting areas of interests directly on the system display.

E mmi CellExplorer – Image analysis software which automatically identifies cells based on selection criteria distinctly specified by morphological parameters predefined individually as such in size, shape, staining and fluorescent markers to allow for automatic dissection.

mmi MultiCap – allows automatic collection of targets in up to eight different IsolationCaps keeping the different targets segregated (e.g. MultiGroup function) or to increase throughput together with the mmi MultiSlide.

mmi MultiSlide – For simultaneous microdissection of up to three slides and to increase throughput.

SERVICES AND CONSUMABLES

MMI the One Stop shop for service and application support:

MMI as a leading supplier of LCM instruments also provides a variety of services and application support. This support is offered throughout the whole value-added chain of sample staining, over microdissection to nucleic acid and protein isolation and analysis. MMI and its partners provide worldwide technical support, guidelines as well as answers to all your questions.

Other MMI services are on-demand end-user training either in-house or on-site, protocols for various applications, scientific publication support, service and maintenance contracts, etc.

MMI also offers on-site protocol development through our own applications specialists' right in your laboratory with your own equipment and personnel providing you with solutions suited to your individual needs.

MMI Consumables

F mmi MembraneSlides

Available in PET, PEN, POL mounted on metal frames or plastic frames in RNase free quality

G mmi IsolationCap

Available in different sizes for specific applications types such as fluorescence or bright field imaging.

H mmi CellChamber

Cell chamber with membrane and special Petri dish for live cell cultures

IBIDI μ -Slide 18-well

18 well for high throughput live cell application. Live cell isolation with mmi IsolationCap.

First Choice in LMD RNA friendly basic Staining Kit

Fast H&E Staining: the whole procedure is done in less than 5 minutes.

D PenScreen for on-screen target identification



E mmi CellExplorer software

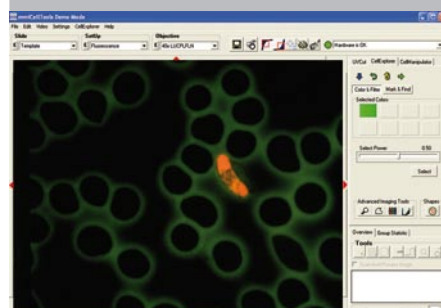

F mmi MembraneSlide

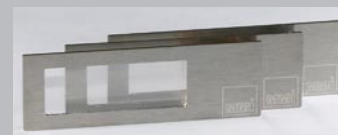

G mmi IsolationCap

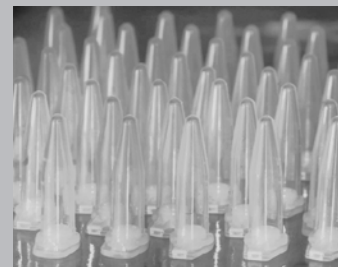

H mmi CellChamber



A mmi CellCut Plus



B Newly designed mmi MultiCap Lift



C mmi LaserBox



D New digital mmi CellCamera



mmi CellCut ^{PLUS}

LEAD THE WAY TO A NEW LEVEL OF LASER MICRODISSECTION

A The third generation of a much acclaimed cutting-edge tool, mmi CellCut Plus combines several proven leading-edge technologies which enable laser microdissection of paraffin and cryo samples, smears and even cell cultures fast and precise. The advancement of the mmi UV-Cut software allows greater capabilities in a user-friendly design.

mmi CellCut Plus: All the solution you need!
Choose mmi CellCut Plus in order to benefit from a range of new advantages that will simplify your work more effectively.

Higher level of automation

B New Caplift design: Newly designed single or multi mmi CapLift in a plug and play module with adjustable cap contact pressure. The complete CapLift can be removed giving full access to the microdissection stage for use in a regular motorized inverted microscope, optical tweezer or other micromanipulation studies.

Available Options:

To increase throughput, mmi MultiCap enables the use of eight mmi IsolationCaps which can be simultaneously attached, facilitating automatic switching from one cap onto the other during group cutting.

The MultiSlide functionality allows the simultaneous microdissection of up to three mmi MembraneSlides.

mmi CellExplorer colour recognition software which automatically recognizes cells under fluorescence and bright field.

Higher level of flexibility

C A more powerful solid state laser is available for application that demand higher lasing energy (mini gels, leaves, wood, thick mammalian tissues, etc.)

Digital camera

D New digital camera. The mmi CellCamera is an ultra sensitive camera with progressive scan possibilities. This will enable users to obtain a much greater image quality and contrast of their samples. A b/w version is also available for sensitive fluorescence applications.

Key Customer benefits:

- Easy operation with high level of automation
- Outstanding image quality with the new digital mmi CellCamera
- Safe reliable operation
- mmi CellCut is compatible to the Olympus IX71 / IX81 or Nikon TE2000-S/E inverted microscopes
- Newly designed single or multi mmi CapLift in a plug and play module with adjustable cap contact pressure
- Ability to use your system with a motorized inverted microscope, optical tweezer or other micromanipulation studies

mmi CellManipulator

A NEW GENERATION OF PROFESSIONAL OPTICAL MULTIBEAM TWEEZERS

mmi CellManipulator is the world's only available commercial optical multibeam tweezer system. This optical trap enables ultra-precise, contact-free manipulation of microscopic particles and the measurement of intracellular activities.

It can be used to study cell-cell interactions, in vitro fertilization or cell fusion. Cell sorting and cell positioning can also be accomplished together with an optional exclusive mmi 4-Quadrant detector enabling the measurement of binding forces or viscosities at sub cellular level.

Function

E The mmi CellManipulator uses a ND-YAG infrared laser with a long wavelength of 1064 nm with up to 3 W of trapping power. The wavelength of the laser does not interfere with the integrity of the living specimens. The intensely focused laser beam can hold, move, rotate, join, separate, stretch or otherwise manipulate up to ten microscopic objects simultaneously in three dimensions. The size of the particles can range from 0.1 to 200 micros in liquids. (System complies with IEC608225-1 Am. 2:2001: Class 1 laser product)

High-performance software

F Advanced software enables comfortable, contact-free, high-precision manipulation of selected particles inside the entire field of view. Each beam can be moved separately, and allows the user to define groups of tweezers points, which can be pushed, rotated, contracted and expanded, as groups or individually as required.

Modularity

G mmi CellManipulator can be used as a stand alone unit or it can be combined with the mmi CellCut at any time to expand the research possibilities. This, for example, would allow the disruption of cells by permitting the introduction of structures or active substances or to initiate cell fusion or work on fluorescence options.

Options

For an even easier and more effective operation, customize or upgrade mmi CellManipulator with a choice of value-adding options such as: high precision 4-Quadrant detectors – use to measure binding forces and viscosities at sub cellular levels.

Key Customer benefits:

- **Unique professional standards in expanding the frontiers of research**
- **Comfortable and safe multibeam operation of up to 10 tweezers points**
- **High performance laser which ensures the integrity of the living specimens**
- **Contact-free and precise movement of selected particles individually or in groups**
- **Easy operation with live video and documentation**

E mmi CellManipulator up to 10 independent trapping beams

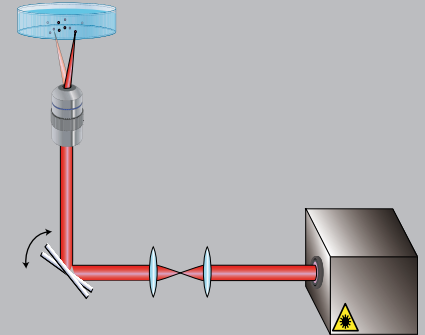

F mmi CellManipulator software easy to use software

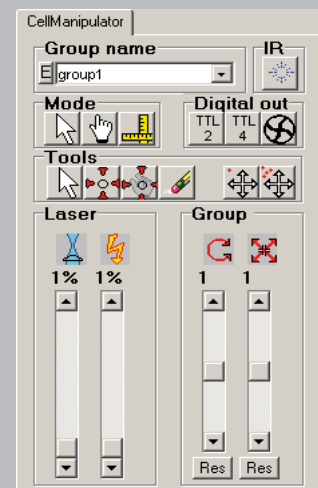

G mmi CellManipulator fully integrated with mmi CellCut



mmi CellCut SPECIFICATIONS

Item	Specifications
Samples	For all relevant application samples (e.g. cryo or paraffin-preserved tissue single cells, cell compartments, cytopspins, chromosomes etc.)
"Live Cell" handling	Positive and negative cell selection / isolation possible
Picosecond UV, solid state laser	Computer controlled Wavelength: 355 nm Pulse duration: <500 psec Pulse energy/average energy: <1 µjoule/appr. 4 mW Repetition rate: <5 kHz System complies with IEC 60825-1 Am. 2: 2001. Class 1M laser product (invisible laser radiation. Do not view directly with optical instruments)
CapLift technology	SW-controlled, covering full slides; unique and contamination free technology
Digital camera with ultra high sensitivity	Digital colour: 2,088 x 1,550 pixels or Digital colour: 1,392 x 1,040 pixels or Digital monochrome: 1,392 x 1,040 pixels Compact housing and FireWire connection
UV-Cut software basic functions	Laser energy and focus control Full slide and Petri dish control Inspection mode with positive target identification Saving multi-user profiles MultiGroup functions across entire samples / slides Autodocumentation for sample, images and parameters
PC and Monitor	Specifications will be continuously updated according to market developments Windows XP Professional, 19" LCD Monitor (with high contrast)
Motorised stage	Computer-controlled for high-precise movement/cutting Travelling range: 120 x 100 mm Step width: 0.075 µm Repositioning accuracy: 1 µm
Options	
Pen Screen system operation	Sensitive 17" or 21" touch screen monitor for user friendly system operation and to allow direct target identification with a special pen
mmi CellExplorer image analysis software	Identifies and cuts automatically defined targets based on user settings
mmi MultiCap (motorized)	Allows automatic collection of targets in up to 8 different IsolationCaps
mmi MultiSlide	For microdissection of 3 slide assemblies
X-Cite metal halide illuminator	cold light, no adjustments, 10x longer lifespan
Possible CellCut system upgrade	
mmi CellManipulator optical tweezer system	Ultra precise, contact-free manipulation of microscopic particles with up to 10 independent beams on a high-quality, Nd: YAG infrared laser

mmi CellCut can be delivered together with Nikon TE2000 series or Olympus IX2 series.



Swiss Precision

MMI AG
Flughofstrasse 37
8152 Glattbrugg, Switzerland
Phone: +41 44 809 10 10
Fax: +41 44 809 10 11
info@molecular-machines.com
www.molecular-machines.com

MMI GmbH
Breslauer Strasse 2
85386 Eching, Germany
Phone: +49 89 319 048 40
Fax: +49 89 319 048 59
info@molecular-machines.com
www.molecular-machines.com

MMI Inc.
P.O. Box 560728
Rockledge, FL 32956-0728, USA
Phone: +1 603 629 9536
Fax: +1 321 978 0304
sales_us@molecular-machines.com
www.molecular-machines.com